

ANT-10AD

5GHz 2x2 Outdoor IP68 Directional 10dBi
Panel Pole/Wall Mount Antenna

EAN Code : 4712757151282



Introduction

The **CERIO ANT-10AD 5GHz 2x2 Outdoor Directional 10dBi Panel Antenna** supports 5.1 to 5.9 GHz and provides superb performance in IEEE 802.11a/an/ac/ax Wi-Fi environment. It supports pole and wall mounting installation and constructed with highly UV-resistant PC material (PC-122U) combined with aluminum alloy to achieve a high-sealing **IP68 waterproof design**. All materials are considered good in water tightness and prevention of rust characteristics.

The **ANT-10AD 5GHz 2x2 outdoor directional Dual Polarization Panel Antenna** provides polarized dual-signal characteristics, allowing multiple antenna applications for 11ac/ax 2T2R MIMO. The user only uses one set of **ANT-10AD Dual Polarization antenna** with 2 sets of N-Type connectors for connection with low-attenuation RF cables and WiFi AP to complete 11ac/ax 2T2R MIMO applications that require multiple antennas. The perfect solution for faster, longer distances with 11ac/ax 2T2R MIMO multi-radio reception and wireless transmission.

Highlight Features

- Supports 5GHz 5.1~5.9GHz IEEE 802.11a/an/ac/ax.
- High Gain: 10dBi.
- **Vertical installation:**
Horizontal beam 35°, Vertical beam 30°
- **Horizontal installation:**
Horizontal beam 30°, Vertical beam 35°
- High performance.
- IP68 waterproof protection rating, suitable for applications in various weather conditions.
- Beaufort scale 17 wind load test certificated.
- Polarized dual-gender design and supports two N-Type (Female) connectors.
- Packaging includes SUS304 stainless steel single-axis adjustable mounting bracket (OW-PKUR).
[\(Please refer to the detailed specifications of OW-PKUR\)](#)
- High-sealing structure with UV resistance, high-temperature durability, combines aluminum alloy and stainless steel materials, ensuring weather resistance and extended lifespan.

Hardware Overview & Dimension

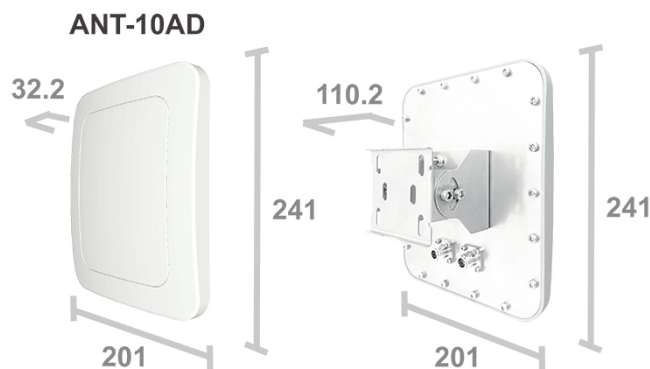

Main Unit Dimension : 241 * 201 * 32.2mm (L x W x H)

Mounting Bracket : 81 * 85 * 78 mm (L x W x H)

Weight : 720g / 1.01kg (Including OW-PKUR bracket)

Adjustable Mounting Bracket Installation (OW-PKUR)



Adjustable bracket match SUS304 Hose Clamp
Available inside diameter : $\varnothing 30 - \varnothing 90\text{mm}$

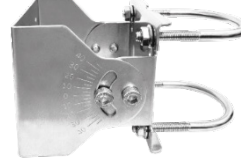

Adjustable bracket match SUS304 M6 U-bolt
Available inside diameter : $\varnothing 34\text{mm} - \varnothing 54\text{mm}$

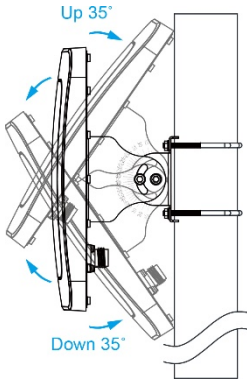

Panel Vertical Installation:
Upward and Downward
Max. 35°

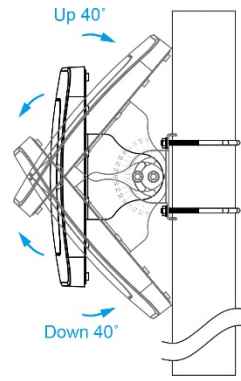

Panel Horizontal Installation:
Upward and Downward
Max. 40°

Product Application

5Ghz Antenna

RF Cables

Outdoor AP Device

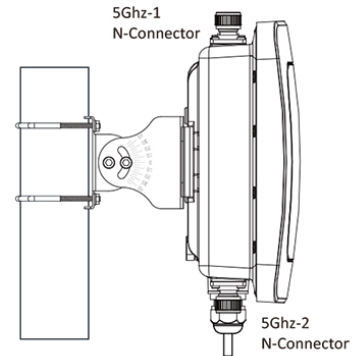
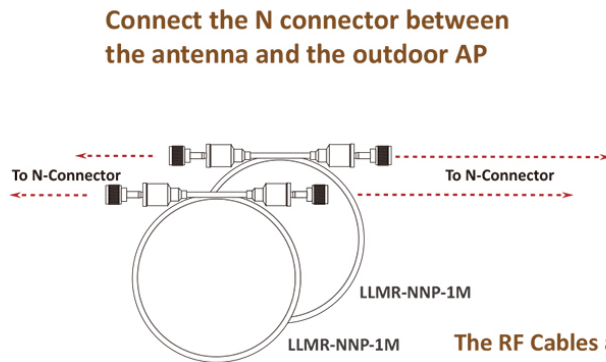
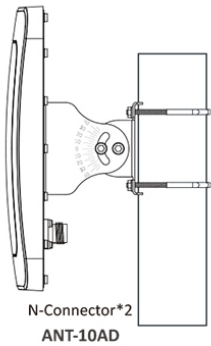

The RF Cables and Outdoor AP Device By Optional

5Ghz Antenna

RF Cables

Surge Arrester

Outdoor AP Device

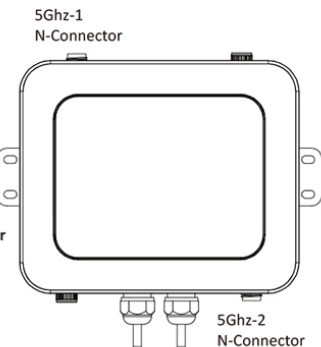
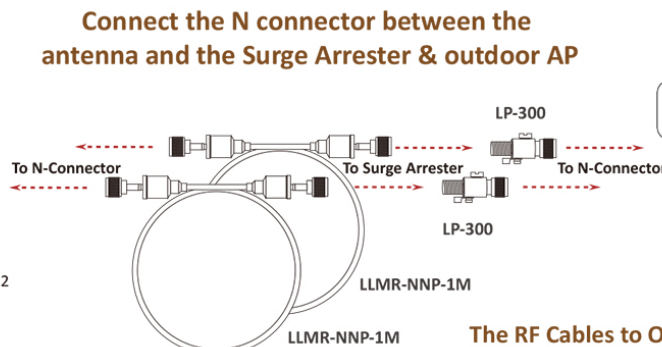
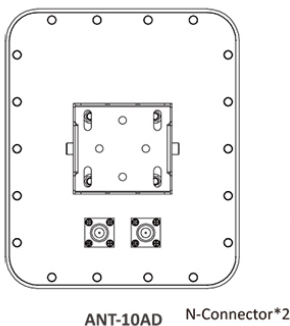

The RF Cables to Outdoor AP Device By Optional

Antenna Coverage

5GHz 2x2 ANT-10AD
When the main body is installed vertically

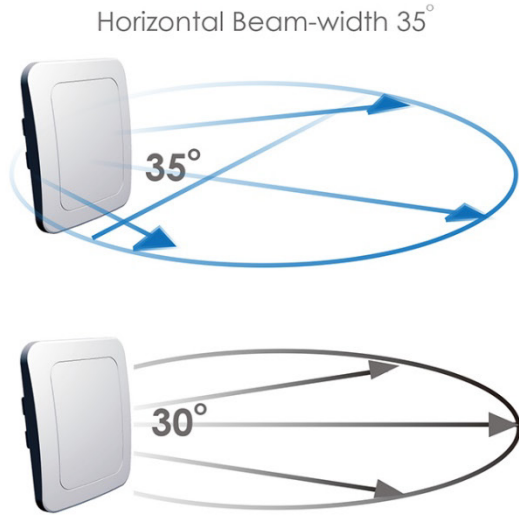

5GHz 2x2 ANT-10AD
When the main body is installed horizontally

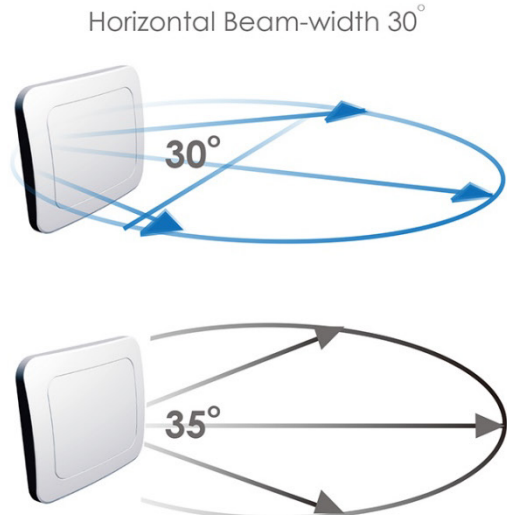

Radiation Pattern

RADIATION PATTERN - 5Ghz 10dBi : ANT-10AD

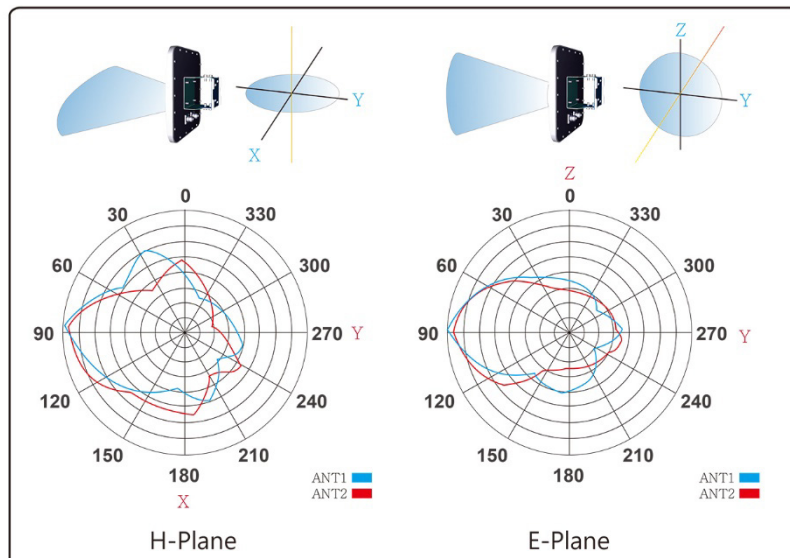

Specifications











Antenna Type	Outdoor Directional Panel Antenna (Horizontally-Polarized) Dual Polarization Antenna
Frequency Range	5.1 ~ 5.9GHz (11a/an/ac/ax)
Network Specification	Wireless 5Ghz IEEE 802.11a/an/ac/ax MIMO
Antenna Gain	10dBi
V.S.W.R	≤1.5
Beam Width	Vertical installation: Horizontal beam 35°, Vertical beam 30° Horizontal installation: Horizontal beam 30°, Vertical beam 35°
Polarization	Vertical & Horizontal (Linear)
Input Impedance	50 Ohms
Materials	UV-resistant PC-122U + 2t aluminum alloy
Connector	N-Type Female x2
Form Factor	Supports Wall / Pole Mounting Installation

Adjustable range (with OW-PKUR mounting bracket)	Adjustable bracket match SUS304 M6 U-bolt Available inside diameter : Ø34mm - Ø 54mm Adjustable bracket match SUS304 Hose Clamp Available inside diameter : Ø30 - Ø90mm Horizontal column hanging axis: 360°horizontal rotation Up and down angle: Maximum upward 40°, downward 40°
Operation Temperature	-50°C - + 85°C
Storage Temperature	-50°C - + 85°C
Humidity	5~90% maximum (non-condensing)
IP Rating	IP68 Rating (waterproof approval)
Maximum Wind Resistance Velocity	Beaufort scale 17 wind load test certificated
Dimension	Antenna: 201*241*32.2 (L x W x H)mm Mounting bracket: 83*85*78 (L x W x H)mm
Weight	720g
Production Location	TW
Certifications	RoHS Compliant

Package Contents

Package Contents	
ANT-10AD Main Unit	x1
Adjustable Pole & Wall Mounting Kit(OW-PKUR)	x1
Quick Installation Guide	x1
Warranty Card	x1

Related Products

Model No.	Photo	Description
ANT-10FD		2.4GHz 2x2 Outdoor IP68 Wide Rang Directional 10dBi Panel Pole/Wall Mount Antenna
ANT-10AD		5GHz 2x2 Outdoor IP68 Directional 10dBi Panel Pole/Wall Mount Antenna
ANT-14AD		5GHz 2x2 Outdoor IP68 Wide Rang Directional 14dBi Panel Pole/Wall Mount Antenna
ANT-18AD		5GHz 2x2 Outdoor IP68 Directional 18dBi Panel Pole/Wall Mount Antenna
ANT-15AQ		5GHz 4x4 Outdoor IP68 Wide Rang Directional 15dBi Panel Pole/Wall Mount Antenna (Can be utilized for dual 2x2 MIMO sets of mesh backbone link stacking applications.)
ANT-05FN-S		2.4Ghz Outdoor thin type Omni 5dBi Plug Antenna
ANT-07AN-S		5Ghz Outdoor thin type Omni 7dBi Plug Antenna
LLMR-NNP-1M		1M N-Plug (Male) to N-Plug (Male) LLMR200 Low Loss RF Antenna Cable
LLMR-NNP-2M		2M N-Plug (Male) to N-Plug (Male) LLMR200 Low Loss RF Antenna Cable
LP-300		11nabg 2.4GHz / 5GHz N-Female to N-Male Lightning Protector