

CS-1216G-8P8T

16 Port Gigabit PoE++ (8 Port AT PoE + 8 Port BT PoE) Switch with 2 SFP Ports (450Watt Power)

EAN Code : 4712757156010



Introduction

CERIO CS-1216G-8P8T is the latest powerful high-performance **16 port PoE Gigabit switch and supports 2 Gigabit SFP uplink ports. It is including 8ports of AT PoE and 8ports of BT PoE and compliant with IEEE 802.3bt, IEEE 802.3at and 802.3af PoE standards.** It defines new green power saving idea on the PoE/PSE Port. It's built-in 450watt internal power supply. All 16 ports capable of 10/100/1000Mbps auto-negotiation operation (NWay). This means the switch could automatically negotiate with connected partners on the network speed and duplex mode.

CS-1216G-8P8T PoE Switch is designed for SMB deployment and can also be upgraded to 1U" chassis for standard rack mounting. It is suitable for setting up surveillance systems in small offices, shops, restaurants, and multi-node network environments, etc., providing convenient and reliable network power supply and data transmission. **It's supporting a maximum PoE output budget of 400 Watt shared for 8 ports of AT PoE and 8 ports of BT PoE** and enough to reliably power devices on all ports. Using UTP Cable to transmit network data and power signals to PoE PD devices (such as POE AP, IP CAM, IP Phone, etc.), so you don't have to worry about the traditional problem of installing a power socket. , easily use PoE to build your network environment.

The **CS-1216G-8P8T** is equipped with a built-in PWM hardware chip and a smart controller that can automatically adjust the fan speed based on real-time temperature monitoring. The fan will automatically stop when it is not needed, enabling smart energy saving and extending the fan's lifespan.

By integrating the data transmitting cable and power cord, it eliminates the hassle of constructing your network. You could easily connect Wireless AP or VoIP phone or IP Camera to this switch without looking for power outlets. Over current protection and circuit shorting protection are also supported to ensure product safety.

Highlight Features

- Complying with IEEE 802.3 10Base-T, IEEE 802.3u 100Base-TX, IEEE 802.3ab 1000Base-T, IEEE 802.3af PoE, IEEE 802.3at PoE+ and IEEE 802.3bt PoE++ standards.
- 16port 10/100/1000Mbps TX Auto-Negotiation Ethernet Switch, supports 16 Port Gigabit PSE / PoE function and compliant with IEEE 802.3af /at/bt PoE standards.
- Supports 2 Gigabit SFP uplink ports and compliant with IEEE 802.3z 1000Base-SX/LX standards.
- Supporting 8ports AT PoE power up to 30Watt and 8ports BT PoE power up to 90Watt.
- Built-in 450 Watt power supply, supports a maximum PoE output budget of 400 Watt, shared for 16 ports of 10/100/1000M PoE ports.
- Full/Half-Duplex capability on each TX port, Auto-learning networking configurations.
- Supports Store & Forward architecture and performs forwarding and filtering.
- Flow control: back pressure for Half-duplex and IEEE 802.3x for Full-duplex mode.
- Support Jumbo Frame 9K.

- Non-blocking & Non-head-of-line blocking full-wire speed forwarding.
- Supports TP interface Auto MDIX function for auto TX/RX swap.
- Automatic Source MAC Address Learning and Aging. Supports up to 8K MAC addresses, Up to 4.1Mbits buffer.
- Supports hardware LED Loop Detectors function, the system can quickly display color differences of LED according to any connection port where a loop occurs.

Hardware Overview

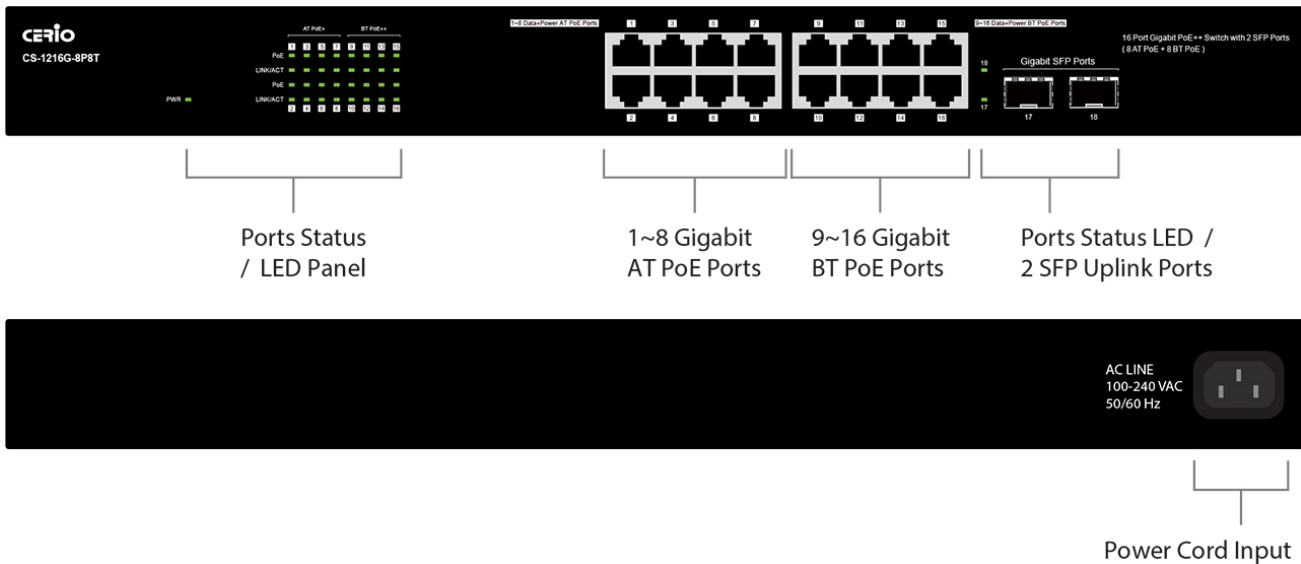

Standards & Hardware Specifications

Network Standards Conformance

IEEE 802.3 10Base-T
 IEEE 802.3u 100Base-TX
 IEEE 802.3ab 1000BASE-T
 IEEE 802.3az Energy Efficient Ethernet- EEE
 IEEE 802.3x Flow Control
 IEEE 802.3af Power over Ethernet (PoE)
 IEEE 802.3at Power over Ethernet Plus (PoE+)
 IEEE 802.3bt Power over Ethernet Plus Plus (PoE++)

Port Configuration

16ports RJ-45 connectors for 10/100/1000Mbps
 (With 8port AT PSE and 8port BT PSE/PoE function)
 2 ports Gigabit SFP

PWM Automatic Temperature Detection/Capability

Built-in PWM real-time temperature detection fan speed automatic control chip.
 PWM temperature detection range: -40°C to +125°C
 Fan Speed: 9000RPM (Max.)
 Air Volume: 10.1 CFM (Max.)

Media Access Protocol

CSMA / CD

Network Media

10BASE –T: UTP Cat. 3 or up,
 100BASE-TX: UTP Cat. 5 or up,
 1000BASE-T: UTP Cat. 5 or up

Transmission Method

Store and Forward

MAC Address Table

8K

Built-in Buffer

4.1Mb

Jumbo Frame

9K

Data Transfer Rate

10/100/1000Mbps (Half-duplex),
 20/200/2000Mbps (Full-duplex)

Auto MDI/MDIX

Yes

LED Indicators

Per Port : Link/ACT Status	x16
Per Port: PoE Status	x16
Per Unit: PWR	x1
Per Unit: SFP Ports	x2

Internal Bus Speed/Exchange Rate

36Gbps/26.784Mpps

Environmental & Mechanical Characteristics

Power Type

450 Watt Internal Power Supply

PoE Power Budget

52V for 400 Watt (shared for all 16 PoE ports)

Power Consumption

14.9 Watt

PoE Power Output

Up to 30W per port (1-8 port support AT PoE output)
 Up to 90W per port (9-16 port support BT PoE output)

Power Requirement

AC 100~240VAC, 50-60Hz Auto-sensing

Operating Temperature

0° to 40° C

Storage Temperature

-40° to 70° C

Operating Humidity

10% to 90% non-condensing

Storage Humidity

5% to 90% non-condensing

Dimensions (W x H x D)

441 x 281 x 44 mm

Unit Weight

3.62kg

Case of Material

Metal case

Production Location

TW

Certifications

FCC, CE, RoHS Compliant



Package Contents

Contents





CS-1216G-8P8T Main Unit	x1
Power Code	x1
Quick Installation Guide Booklet	x1
19" Rack Mount Brackets	x1
Warranty Card	x1

SFP / SFP+ / RJ45 Copper Transceiver Module

1.25Gbps/Gigabit SFP/RJ45 Series

Model No.	Photo	Description	Compatible Switch
SRJ-GT		1000BASE-T SFP Copper RJ45 Transceiver 100m	CS-1224G CS-2424G CS-34816XG
SLC-GSXM		1.25Gbps SFP SX 850nm 550m LC Multi-Mode DDM	CS-1216G-16P CS-1216G-8P8T CS-1224G-24P
SLC-GLXS10		1.25Gbps SFP LX 1310nm 10KM LC Single-Mode DDM	CS-2208G-8P CS-2424G-24P CS-3416G-16P CS-3424G-24P

10Gbps SFP+/RJ45 Series

Model No.	Photo	Description	Compatible Switch
SRJ-10GT		10GBASE-T SFP+ Copper RJ45 Transceiver 30m	CS-2648XG CS-34816XG CS-2648XG-48P
SLC-10GSRM		10GBASE-SR SFP+ 850nm 300m LC Multi-Mode DDM	
SLC-10GLRS10		10GBASE-LR SFP+ 1310nm 10KM LC Single-Mode DDM	
AOC-10G01		1M 10GBASE-T SFP+ to SFP+ Active Optical Cables Cable	
AOC-10G03		3M 10GBASE-T SFP+ to SFP+ Active Optical Cables Cable	